

# Safie Adjustable

Installation manual

## Important Safety Instructions

Basic safety precautions should always be followed when installing, including the following:



- 1: Read all instructions.
- 2: Licensed electrician for installation only.
- 3: Always ensure the power is off and the fitting has cooled down before performing any maintenance, cleaning, changing the globe or adjustment to the fitting.
- 4: Do not install any luminaire near a heat source.
- 5: Do not exceed the nominal supply voltage or amperage ratings.
- 6: To avoid injury or damage to the fitting, please ensure that power leads and screws are secure before connecting the power.
- 7: The luminaire should be positioned so that prolonged staring into the luminaire at a distance closer than 2,2m is not expected.

## Installation Spacing

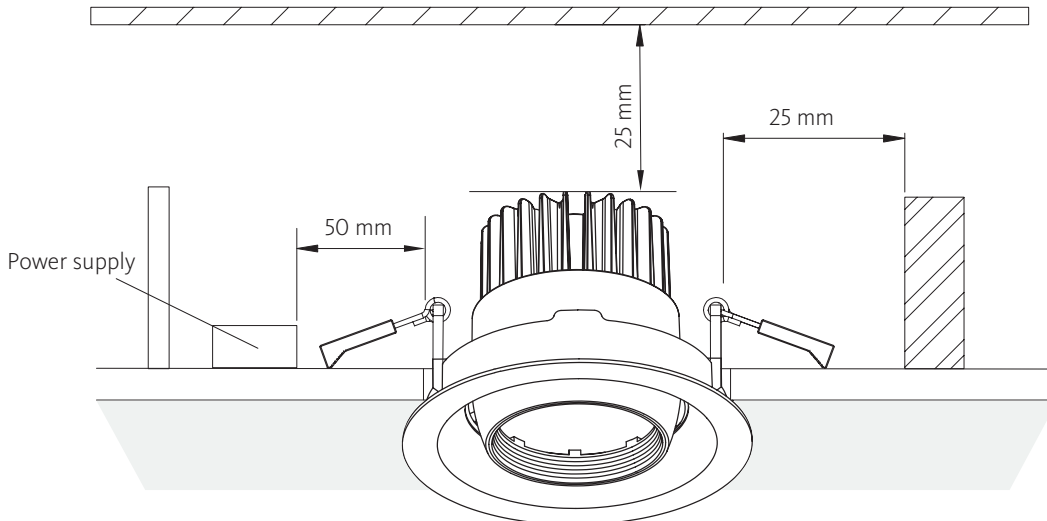

**Note:** Before installation, please check the IP label on the luminaire to choose the right place to install.

IP20	Indoor use only, do not use in wet or damp place
------	--

**Note:** Ceiling cutout reference table.

Downlight diameter (mm)	150
Ceiling cutout (mm)	135-140

### Downlight with external driver

**1**

Open a hole according to the cutout size of the LED downlight.

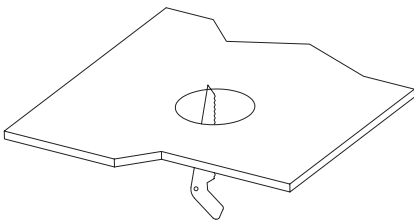

**2**

Use screwdriver to open the driver terminal cover. Connect the wires according to the wiring diagram that comes with the driver, then fix the cover back.

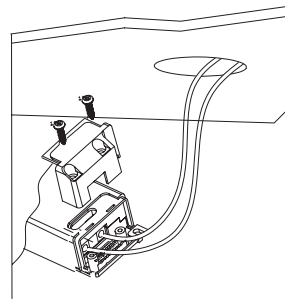

**3**

Connect the downlight with the driver. Hold back the spring clip, then push the downlight into the hole.

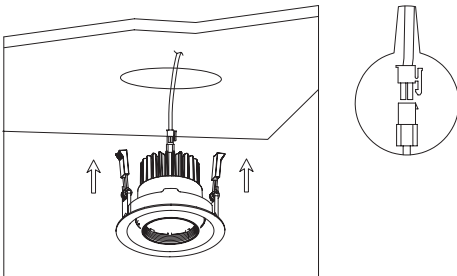

**4**

Make sure the downlight is fixed tightly in the ceiling. Turn the power on.

